

FAMILY LINE

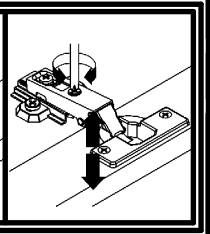
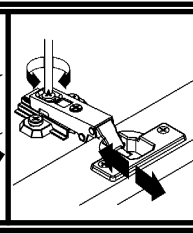
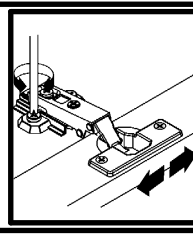
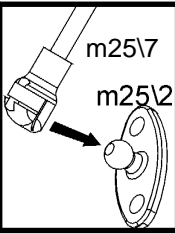
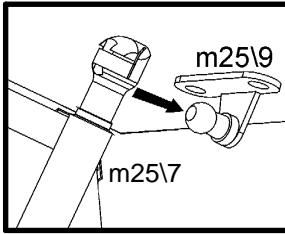
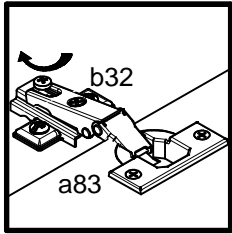
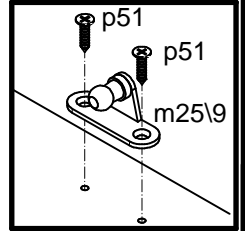
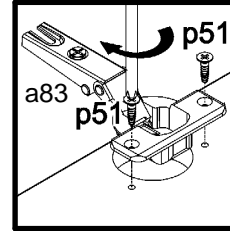
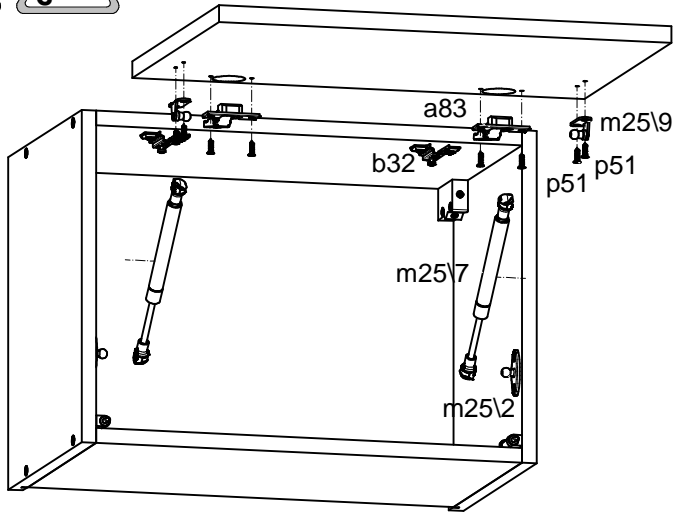
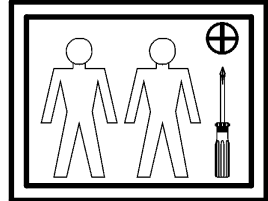

1 / 1

P28-K10-MONT_FRN_NR_08-M_IN7-KOR01.idw

FAMILY LINE

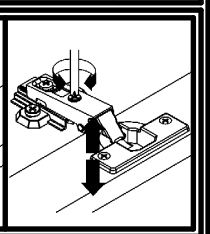
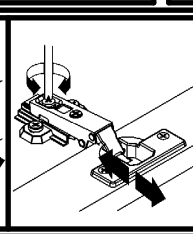
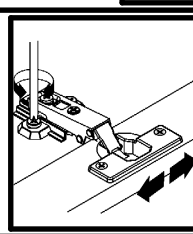
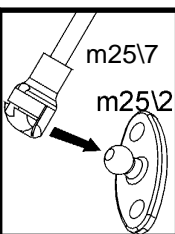
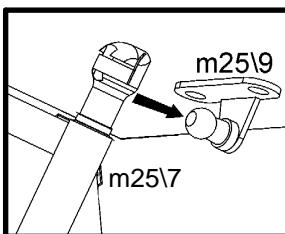
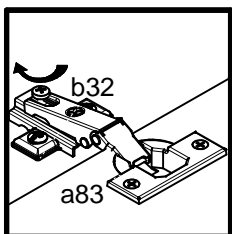
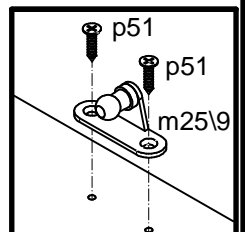
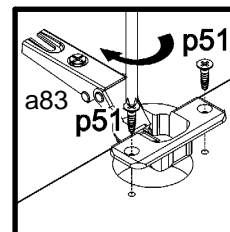
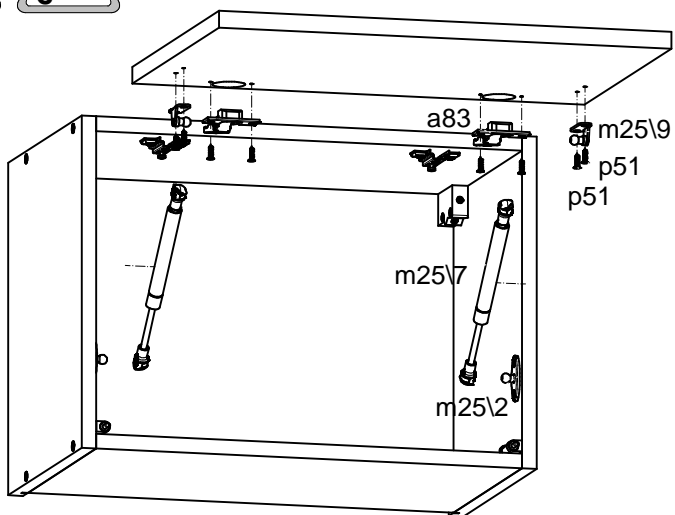
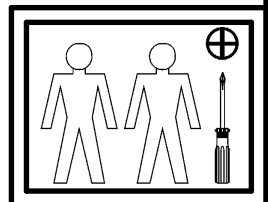

1 / 1

P28-K10-MONT_FRN_NR_08-M_IN7-KOR01.idw